

Enviroline 376F-30 Application Guidelines

Prepared by: M&PC Technical Operations Department

International Paint Ltd.
www.international-pc.com

The information in this guideline is not intended to be exhaustive; any person using the product for any purpose other than that specifically recommended in this guideline without first obtaining written confirmation from us as to the suitability of the product for the intended purpose does so at their own risk. All advice given or statements made about the product (whether in this guideline or otherwise) is correct to the best of our knowledge but we have no control over the quality or the condition of the substrate or the many factors affecting the use and application of the product. THEREFORE, UNLESS WE SPECIFICALLY AGREE IN WRITING TO DO SO, WE DO NOT ACCEPT ANY LIABILITY AT ALL FOR THE PERFORMANCE OF THE PRODUCT OR FOR (SUBJECT TO THE MAXIMUM EXTENT PERMITTED BY LAW) ANY LOSS OR DAMAGE ARISING OUT OF THE USE OF THE PRODUCT. WE HEREBY DISCLAIM ANY WARRANTIES OR REPRESENTATIONS, EXPRESS OR IMPLIED, BY OPERATION OF LAW OR OTHERWISE, INCLUDING WITHOUT LIMITATION, ANY IMPLIED WARRANTY OF MERCHANTABILITY OR FITNESS FOR A PARTICULAR PURPOSE. All products supplied and technical advice given are subject to our Conditions of Sale. You should request a copy of this document and review it carefully. The information contained in this guideline is liable to modification from time to time in the light of experience and our policy of continuous development. It is the user's responsibility to check with their local International Paint representative that this guideline is current prior to using the product.

ID 376F-30_uk	Rev. 04	Date 14/12/2015	Enviroline 376F-30	Page 1 of 11
-------------------------	-------------------	---------------------------	---------------------------	---------------------

The International Paint Application Guidelines have been produced and revised in line with the Worldwide Protective Coatings Product Range. The purpose of the guidelines is to ensure that the product, as applied, provides the required level of durability.

Successful in-service performance of a coating system depends upon both the correct choice of product(s) and the adoption of the correct guidelines for surface preparation and paint application.

The responsibilities for achieving the specific standards outlined, and for carrying out surface preparation and paint application, rest with the Contracting Company. Under no circumstances do these responsibilities rest with International Paint. We will generally provide for the presence of a Technical Service Representative at key stages during the performance of the contract. The role of the International Paint Technical Service Representative is advisory only unless otherwise specified in the terms and conditions of the contract. The information contained herein presents guidelines for the application of Enviroline 376F-30 to correctly prepared surfaces.

Table of Contents

1. Introduction
2. Environmental Conditions for Application
3. Application Procedure
4. Application
5. Technical Inspection
6. General Notes
 - 6.1 Ventilation
 - 6.2 Heating
 - 6.3 Lighting
 - 6.4 Storage of Product at Point of Application
 - 6.5 Weather Shelters
 - 6.6 Cleaning
 - 6.7 Stripe Coating
 - 6.8 Pit Filling
7. Repair Procedure
8. Health and Safety

APPENDIX 1 – FABRICATION RECTIFICATION

ID 376F-30_uk	Rev. 04	Date 14/12/2015	Enviroline 376F-30	Page 2 of 11
-------------------------	-------------------	---------------------------	---------------------------	---------------------

1. INTRODUCTION

1.1 Surface Preparation

In common with most protective coatings schemes, the performance level of Enviroline 376F-30 is ultimately determined by degree of surface preparation. The higher the degree of surface preparation achieved, the greater the long-term performance.

For optimum performance, all surfaces to be coated should be clean, dry and free from contamination including dirt, salts, oil and grease.

Steel

This product is suitable for application to new steel.

Prior to paint application all surfaces should be assessed and treated in accordance with ISO 8504:2000. Where necessary, remove weld spatter, smooth weld seams and treat sharp edges or other fabrication faults; see Appendix 1 of this document, ISO 8501-3 grade 3 and/or NACE RP0178 grade C. In cases where the substrate is corroded or pitted, it may be necessary to fresh water wash the areas after abrasive blasting, then re-blast, in order to ensure complete removal of soluble corrosion products. The maximum allowed total soluble salt contamination on the steel before application of the Enviroline 376F-30 scheme is 10µg/cm².

All steel surfaces to be coated should be correctly prepared prior to application of the coating system. The preferred method of preparation is abrasive blast cleaning to Sa3 (ISO 8501-1:2007) or SSPC-SP5 or NACE #1.

For less aggressive service conditions, it is acceptable to abrasive blast clean to Sa2½ (ISO 8501-1:2007) or SSPC SP10 or NACE #2.

Compressed air used for blasting must be clean, oil free and dry. The pressure should be at least 7kg/cm² (100psi) at the nozzle.

Abrasives used for blasting must be dry and free from dirt, oil, and grease and suitable for producing the standard of cleanliness and profile specified. The required amplitude of the blast profile depends upon the type of coating to be applied. Measurement on site should be by profile gauge or other mutually acceptable instrument. A minimum surface profile of 75 microns (3 mils) is recommended.

Concrete

Consult the International Concrete Surface Preparation Guide document for further information.

Other Substrates

Product is not suitable for application to other substrates.

1.2 Typical Specification

Coat	Product	DFT (microns)			DFT (mils)		
		Spec	Min	Max	Spec	Min	Max
Stripe *	Enviroline 376F-30	175	125	250	7	5	10
Full	Enviroline 376F-30	750	(500)	(1000)	30	(20)	(40)

* All areas itemized in Section 6.7 are to receive a stripe coat.

1.3 Notes

The detailed project coating specification provided by International Protective Coatings must be followed at all times. This will include specific details with regard to surface preparation and dry film thickness requirements.

Specific project requirements will be dependent upon the service end use and operating conditions of the tank or vessel. Always consult International Protective Coatings to confirm that Enviroline 376F-30 is suitable for contact with the product to be stored.

Refer to the Enviroline 376F-30 datasheet for precise overcoating intervals, pot life and curing requirements.

2. ENVIRONMENTAL CONDITIONS FOR APPLICATION

Enviroline 376F-30 will not cure adequately at ambient temperatures below 13°C (55°F). For maximum performance the temperature should be greater than 13°C (55°F).

Coatings should only be applied to surfaces which have been maintained in a dry condition with the steel temperature at least 3°C (5°F) above the dew point for more than one hour (in order to prevent condensation). The surfaces must be visibly dry and clean at the time of application. This condition must be maintained until the coating is cured. For all application steps, the surface temperature, air temperature and material temperature should be between 10°C (50°F) and 49°C (120°F). Application should not take place when relative humidity is more than 80% or the surface temperature is less than 3°C (5°F) above the dew point. Consult the regional International Paint technical representative for guidance on application to substrates at higher temperatures.

Dehumidification, air conditioning and/or heating equipment may be necessary to control environmental conditions but care should be taken when choosing heating methods, as some heaters can increase the local relative humidity.

Microclimate should be monitored in between applications. Changes in microclimate may affect overcoating intervals. Additionally, exposure to UV sources will reduce the overcoating interval of the Enviroline 376F-30.

3. APPLICATION PROCEDURE

Ensure, prior to application, that the minimum environmental conditions specified in Section 2 are achieved. Facility should be made to ensure these conditions are maintained throughout the painting program.

The area to be coated should be primed as per the specification and in accordance with the primer technical data sheet. All areas itemised in Section 6.7 are to receive a stripe coat. The stripe coat should be applied within the overcoating intervals specified in the relevant product data sheet. Unless advised otherwise, all areas are to receive the full lining scheme to the specified dry film thickness as specified by International Protective Coatings.

When hard dry, the dry film thickness may be measured by all interested parties to confirm compliance with the specification. Any areas of under thickness are to be brought up to the minimum thickness specified. This must be carried out within the overcoating intervals specified for the product.

All damages are to be repaired in accordance with Section 7, according to size.

On completion of installation, the final coating should be inspected using a suitable non-destructive magnetic gauge to verify average lining thickness. Following testing, any defective area should be repaired in accordance with the guidelines outlined in this document.

Ensure that fresh cans are used after each unit is applied – do not refill the old cans.

ID 376F-30_uk	Rev. 04	Date 14/12/2015	Enviroline 376F-30	Page 4 of 11
-------------------------	-------------------	---------------------------	---------------------------	--------------

4. APPLICATION

4.1 Mixing

Efficient mechanical stirrers for the correct mixing of paint must be used.

For single leg airless spray application the mixed paint must be between 35°C (95°F) and 38°C (100°F) upon completion of mixing. This is best achieved by heating of the individual components to between 30°C (86°F) and 35°C (95°F) in a thermostatically controlled storage facility.

Each component should first be pre-mixed in its own container to ensure proper dispersion of contents. Scraping the sides and bottom of the container is required. Part B should then be combined with Part A; this can be carried out in the 20 litre (5-gallon) container provided as part of the standard Enviroline unit, or in a separate hopper. The combined components should then be agitated until thoroughly mixed with one another, at 400-600rpm, checking to see if the combined component colour is uniform and complete. Excessive rpm will induce air into the mixture and is not recommended. The equipment recommended for mixing consists of a 13mm (½") drive reversible variable speed drill, an Enviroline mixing paddle or equivalent and a thermometer. The temperature of the material should be monitored during mixing.

For plural component application the individual components should be heated to 30°C (86°F) and fully pre-mixed in its own container to ensure proper dispersion of contents prior to loading into the appropriate hoppers on the spray unit (this is to facilitate the circulation and heating required for application). Facility for continued mixing will assist in maintaining uniform temperature during application.

4.2 Airless Spray ('Hot Potting')

Mix the Enviroline 376F-30 in accordance with the product data sheet.

Available air pressure and capacity for spray equipment should be at least 7kg/cm² and 7.0m³/min (100 psi and 250 cfm). All spray equipment must be in good working order and be capable of performing to the output requirements defined in International Paint product technical data sheets. **DO NOT THIN.**

It is recommended that airless spray pump ratios of 56:1 or greater should be used. Teflon packings are recommended. Remove all filters from the spray unit and airless spray guns. Tips should be the size range stated on the relevant product data sheet and be in good condition. Paint line (hose) should be of 13mm, (½ inch), diameter, a maximum length of 45m (148ft), with a 10mm, (3/8 inch), diameter and 3m (10ft) whip-end. Both line and whip-end should be rated at 5000psi (351 kg/cm²)

The use of trace heated lines or an inline heater is recommended to maintain the temperature required for application (35-37°C, [95°F – 100°F]).

Areas of overspray should be sanded down prior to overcoating.

4.3 Plural Component Spray Application

Heated plural component spray application is the most practical and preferred method when working with fast curing, short pot life materials, especially when lining large areas and applying at lower temperatures.

A pump capable of accurately delivering a 2:1 mix ratio is essential (Graco 56:1 or greater power ratio is recommended).

Remove all filters from the spray unit and airless spray guns

ID 376F-30_uk	Rev. 04	Date 14/12/2015	Enviroline 376F-30	Page 5 of 11
------------------	------------	--------------------	---------------------------	--------------

Two (2) ½" x 12 elemental in-line static mixers are required – these are located in line after the mixer manifold on the plural component equipment. Heated tanks and heated lines up to 66°C (150°F) may be necessary.

The Part A fluid line should be 13mm (½") internal diameter minimum. The Part B fluid line should be 13mm, (½") internal diameter, although 10mm, (3/8") internal diameter minimum is also possible. The high pressure solvent fluid line should be 6mm, (¼"), internal diameter minimum. Tips should be the size range 31-36 thou (0.78 – 0.91mm) – reversible tips are suggested. Paint line (hose) should be 13mm diameter (½ inch), maximum length 45m, with a 10mm (3/8 inch) diameter, 3m (10ft) whip-end. Both line and whip-end should be rated at 5000psi (351 kg/cm2).

Plural component application requires volumetric check of the mix ratio (utilizing a ratio monitoring system) before and during the application process, although any variation in product colour during application will also indicate that the plural pump is off ratio.

The plural component unit should have facility for heating of the base and curing agent components.

Part A should be heated to a maximum of 60°C (140°F) and Part B to a maximum of 40°C (105°F) under agitation in the plural component equipment.

The use of trace heated lines or an inline heater may be required to maintain the temperature required for application.

Important Note: A pressure drop is associated with paint lines. This pressure drop needs to be considered and depends upon the following factors:

- The viscosity of the paint. Higher viscosity paints produce greater pressure drops than low viscosity paints.
- The length of the paint line. Longer lines produce greater pressure drops
- The internal diameter of the paint line.
- Flow rate of paint through the line.

5. TECHNICAL INSPECTION

Project control by regular inspection and agreement on future action is vital to a successful coating project, and in maximising the potential of a coating system.

All parties involved in the coating work must agree an inspection procedure prior to work commencing, this should outline how and when both work and inspection will be undertaken.

All thicknesses are to be checked by the coatings inspector on site. Inspection equipment for measurement of profile depth, humidity, wet and dry film thickness, etc., should be within calibration limits.

NOTE: When measuring the dry film thickness of coatings, the DFT gauge must be calibrated in accordance with the manufacturer's instructions.

Measurement of dry film thickness is described in ISO Standard 2808:2007 - Method 6A or SSPC PA2 Level 3. Any substandard areas are to be rectified.

'Spark' testing (holiday testing) will detect cracks, holidays and thin spots within a coating and should be carried out in accordance with NACE SP0188. Due to the destructive nature of the test, spark testing should only be done once, prior to the actual use of the coating under projected service conditions and at the recommended voltages, 100 volts per 25µm is recommended.

6. GENERAL NOTES

ID 376F-30_uk	Rev. 04	Date 14/12/2015	Enviroline 376F-30	Page 6 of 11
------------------	------------	--------------------	---------------------------	--------------

6.1 Ventilation

During and after coating application it is essential that solvent vapour is removed to ensure that the level present in the atmosphere does not rise above that recommended in the section (8.2) dealing with “Danger of Explosion and Fire”. This means that the ventilation system must be arranged such that “dead spaces” do not exist. The ventilation must be continued both during the time that application is proceeding and also whilst solvent is released from the paint film during the drying process. Particular care must be taken to ensure that solvent vapour, which is heavier than air, does not accumulate in the lower areas of the tanks. The extracted air must be balanced with fresh air being introduced into the encapsulated area. Equipment used must not re-introduce abrasive dust, solvent vapour etc., into the area where the coated articles are stored.

Ventilating to 10% of the LEL is considered to provide a reasonable margin of safety to allow for possible higher local concentrations. Care should be taken when setting up ventilation/extraction systems, to ensure that 10% figure is not exceeded. Responsibility rests with the contractor to ensure that the requisite equipment is available and operated in such a way that these requirements are met. International Paint will provide all of the information needed to allow the contractor to calculate ventilation requirements. However, International Paint does not accept responsibility for the equipment, its operation, or the monitoring necessary to ensure that the requisite ventilation requirements are met.

All equipment used after the commencement of paint application must be electrically safe in operation.

The amount of air per minute for ventilating to 10% of the LEL (lower explosive limit) can be regarded as the required air quantity multiplied by rate of application per minute. The required air quantity is the amount of air needed for each litre of paint to ventilate to the required level. International Paint should be contacted for RAQ and LEL values for the appropriate products. In the event of a failure of the extraction/ventilation system paint application must be stopped and the area evacuated of personnel immediately. The level of ventilation employed must take account of the Lower Explosive Limit (LEL) of the product being applied and comply with local legislative requirements. International Paint recommends that this is such that vapour concentrations do not exceed 10% of the LEL.

6.2 Heating

If heating is necessary to satisfy the painting specification, it should be by means of a heat exchange system, i.e. air admitted to the encapsulated area should not pass directly through a combustion chamber, to avoid an increase in humidity.

6.3 Lighting

Lighting during painting must be electrically safe and provide suitable illumination for all work. As a guide, lighting may be considered suitable if this text can be read at a distance of 30 centimeters (12 inches) from the eye. Ideally, the lighting should be powerful mains supplied spotlight with background lighting on at all times in the interests of safety. Powerful mains spotlighting must be provided when inspection work is being carried out.

6.4 Storage of Product at Point of Application

The paint must be stored out of direct sunlight so that the temperature of the material will not exceed 25°C (77°F) for prolonged periods of time. In some regions, this may require the use of refrigerated facilities.

Provision must be made for heated storage of the Enviroline 376F-30 to ensure a temperature of 35°C (95°F) is achieved for the Part A and 30°C (86°F) for the Part B prior to application.

ID 376F-30_uk	Rev. 04	Date 14/12/2015	Enviroline 376F-30	Page 7 of 11
------------------	------------	--------------------	---------------------------	--------------

6.5 Weather Shelters

Weather shelters should be made available to cover application equipment during mixing and application of material. This should also prevent contamination from entering the area where application is underway.

6.6 Cleaning

Prior to initial blasting inspection, the bulk of spent grit should be removed. Any substandard areas should be identified and should be brought up to the specified standard. Following provisional approval of the blast standard, all remaining traces of grit and dust should be removed from all areas. Final approval of a substrate for coating application should be confirmed after final cleaning.

6.7 Stripe Coating

Stripe coating is an essential part of good painting practice. Typical areas where stripe coats must be applied include:

- behind bars
- cut outs e.g. scallops, manholes etc.,
- welds
- areas of pitting
- plate edges
- areas of difficult access
- small fitments of difficult configuration

Note: The above list is not comprehensive, all areas must be included. The diagrams following indicate key areas requiring stripe coating:

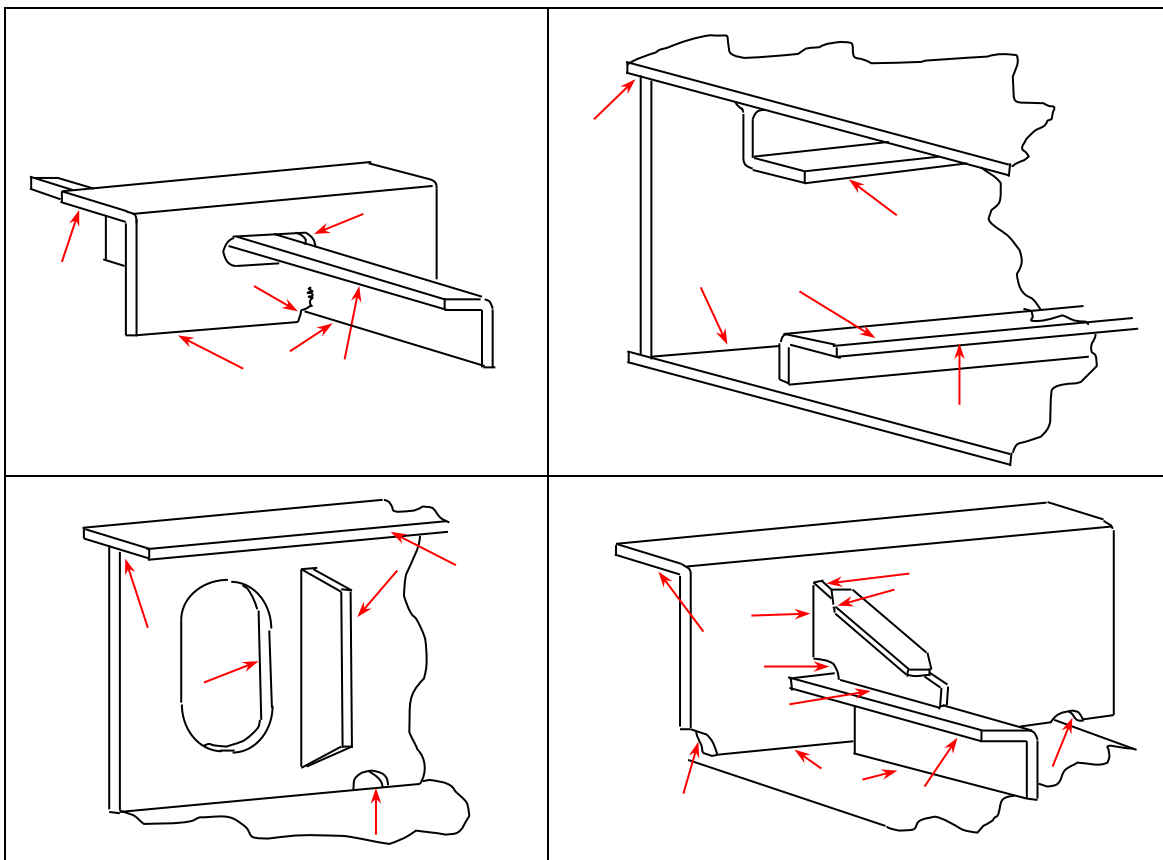

In general, stripe coats should be applied by brush. Application by roller should be limited to the inside of scallops.

6.8 Pit Filling

ID 376F-30_uk	Rev. 04	Date 14/12/2015	Enviroline 376F-30	Page 8 of 11
------------------	------------	--------------------	---------------------------	--------------

Areas showing deep pitting should be filled with Enviroline 376F-30 prior to application of the full scheme. This can be best accomplished by spraying material over the pitted area and then ensuring penetration by use of a squeegee (or by back-rolling). The filled pits may then be overcoated “wet on wet” with Enviroline 376F-30 although allowing a minimum of 15 minutes is recommended, to allow the material to flow into the pits, before overcoating.

7. REPAIR PROCEDURES

These repair procedures are recommended for damages either at the initial coating stage or where breakdown of coating has occurred during service.

Minor Repairs

Minor repairs are areas damaged either at the initial coating stage or caused during service, of an area up to approximately 40 square inches. The principal requirements are:

The area to be repaired must be fresh water washed and dry.

Remove any corrosion and coatings back to a firm tight edge by means of either:

- vacuum blasting (to achieve the profile specified for new substrates)
- hand tools, i.e. disc sander and grinder (to a standard of SSPC SP11 with a profile of 40-50µm (1.6-2 mils)).

Any pits which do not need re-welding should be prepared by cone shaped grinder.

Abrade area immediately surrounding repair to provide key for subsequent paint application. Apply the paint system in accordance with our recommendations. If small areas are involved and application is by brush, several coats may be required to achieve the correct dry film thickness.

Touch up of damage caused during de-staging is to be done by brush with Enviroline 376F-30 to a minimum dry film thickness of 800 microns (32 mils).

Any repair area more extensive than this should be treated as for new surfaces; i.e. re-blast to the specified standard and apply the full specification.

8. HEALTH AND SAFETY

8.1 Introduction

Some coatings contain volatile flammable organic solvents which can form explosive mixtures with air. Safety precautions must be taken whilst applying this type of coating in enclosed areas. Detailed attention must be given to the following points:

- Danger of explosion or fire
- Provision of a suitable breathing environment for workers.
- Prevention of skin irritation problems.
- Use of paints which have been specially formulated for use in tanks.

8.2 Danger of Explosion or Fire

The key factors in preventing an explosion or fire are:

ID 376F-30_uk	Rev. 04	Date 14/12/2015	Enviroline 376F-30	Page 9 of 11
------------------	------------	--------------------	---------------------------	--------------

- Adequate ventilation.
- Elimination of naked flames, sparks and any ignition sources.

Any organic solvent based coating could, merely by the normal process of drying, give off sufficient solvent vapour to produce an explosive mixture in an enclosed area when the vapour concentration reaches or exceeds 1% by volume in air. However, at 1% the solvents in the coatings produce an intolerably unpleasant odour, (often with irritating skin effects) and smarting of the eyes. These symptoms must be taken as a warning sign that better ventilation is needed. 0.1% solvent vapour in air is normally recommended to give a tenfold safety margin and at this concentration, no explosion can occur and no operator effects should be noticed.

8.3 Elimination of Ignition Sources

Safety is the overriding consideration with this type of coating work, and the Site Safety Department must be made fully aware of all aspects of the operation.

Welding, cutting or grinding in the immediate vicinity should be forbidden until paint fumes are totally dispersed. Lights, including hand torches, must be certified by the manufacturer as flash proof and suitable for use in solvent laden atmospheres. Smoking must be prohibited in the area or near to extraction systems. No electrical junction boxes should be allowed in the area where application is carried out. Airless spray equipment must be earthed (because of the danger of static electricity build-up)

Mobile telephones, electrical cameras, and any equipment that is not intrinsically safe, must not be used in the area or near to extraction systems.

8.4 Solvent Vapour and Paint Mists - Protection of Painting Personnel

No ventilation system can reduce solvent vapour levels to below the Occupational Exposure Limit for solvents whilst coating is in operation. Painters should, therefore, wear air fed hoods or pressure fed masks with additional eye protection. (Please note: air fed hoods which provide a curtain of air across the visor are available. These help to prevent settlement of spray mist on the visor). Normal protective clothing must be worn, e.g. overalls, gloves, and suitable footwear of non-spark type.

8.5 Skin Irritation

If proper protective clothing has been worn, e.g. overalls, gloves, air fed hood etc., no discomfort should be experienced from skin irritation. Any small areas not protected by clothing, e.g. wrists or neck, can be treated with a non-greasy barrier cream. (Petroleum jelly is not recommended as this can assist the transport of solvents into the skin).

Any areas of skin accidentally contaminated with paint must be thoroughly washed with soap and water. A skin conditioner that is designed to replace the natural oils in the skin can be used.

Note

1. The preceding safety information is given for guidance only.
2. It is imperative that, prior to the commencement of any tank coating project, local Regulations regarding Health and Safety be consulted.

 **International** and all product names mentioned in this publication are trademarks of, or licensed to, Akzo Nobel.

ID 376F-30_uk	Rev. 04	Date 14/12/2015	Enviroline 376F-30	Page 10 of 11
------------------	------------	--------------------	---------------------------	---------------

APPENDIX A – FABRICATION RECTIFICATION

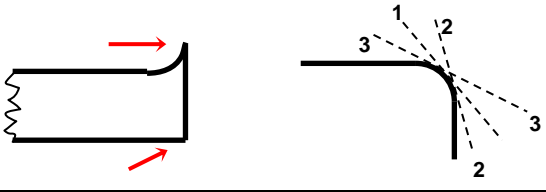
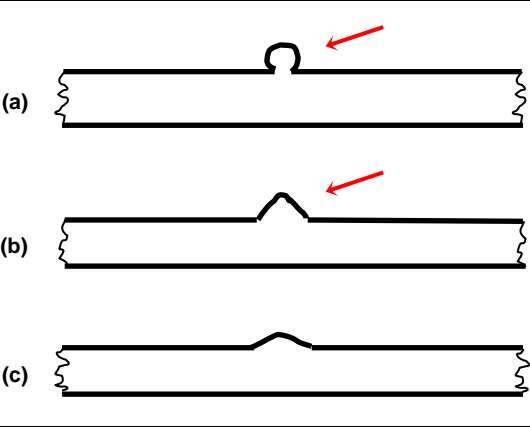
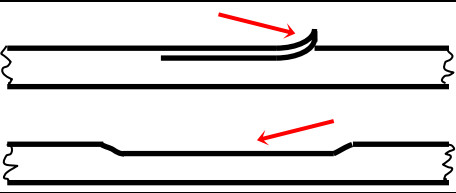
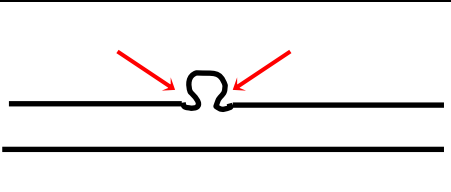
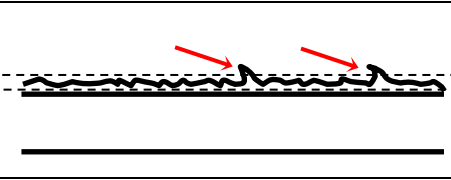
ITEM	PROBLEM / SOLUTION
Sharp Edge	<p>Remove sharp edges or gas cutting edges with grinder or disc sander to achieve a radius of 1.5mm-2.0mm</p> 
Weld Spatter	<p>Remove spatter observed before blasting by grinder, chipping hammer etc.</p> <p>For spatter observed after blasting: Remove with chipping hammer /scraper etc. Where spatter is sharp, use disc sander or grinder until obtuse Obtuse spatter – no treatment required</p> 
Plate Lamination	<p>Any lamination to be removed by grinder or disc sander</p> 
Undercut	<p>Where undercut is to a depth exceeding 1mm and a width smaller than the depth, repair by welding or grinding may be necessary</p> 
Manual Weld	<p>For welding bead with surface irregularity or with excessive sharp edges, remove by disc sander or grinder</p> 
Gas Cut Surface	<p>For surfaces of excessive irregularity, remove by disc sander or grinder</p> 