

APPLICATION GUIDELINES

CARGO OIL TANKS

Interline® 704HS

Revision 2

Issue Date: 23th February 2021

**For compliance with IMO PSPC MSC.288(87)
for Cargo Oil Tanks of Crude Oil Tankers
at Newbuilding only.**

Application Guidelines Interline® 704HS

Revision 2 Date 23rd February 2021



<u>CONTENTS</u>	<u>Page</u>
1. SCOPE AND PURPOSE	3
2. PRODUCT SPECIFICATION AND PRODUCT CURE GRAPHS	4
2.1 Surface Preparation	4
2.2 Specification	4
2.3 Film Thickness	4
2.4 Notes	5
2.5 Product Cure Graphs	6
3. COATING APPLICATION PROCEDURES	9
4. TECHNICAL INSPECTION AND PROJECT CONTROL	13
5. GENERAL NOTES	14
5.1 Tank condition	14
5.2 Steelwork Preparation	15
5.3 Scaffolding	16
5.4 Cargo Lines	16
5.5 Heating Coils	17
5.6 Ventilation	17
5.7 Dehumidification	18
5.8 Heating	18
5.9 Lighting	19
5.10 Storage at point of application	19
5.11 Grit Blasting	19
5.12 Cleaning	20
5.13 Paint Application	21
5.14 Stripe Coats	22
5.15 Coating Procedures	23
6. REPAIR PROCEDURES	24
7. HEALTH & SAFETY	25

1. SCOPE AND PURPOSE

The International Paint Cargo Oil Tank Application Guidelines have been produced and revised in line with the Worldwide Marine product range and IMO PSPC MSC.288(87) for Cargo Oil Tanks of Crude Oil Tankers and Crude Oil Tanker/Product Carrier hybrid vessels. The purpose of the guidelines is to ensure that a coating system, as applied, provides adequate protection against corrosion and resistance to cargoes in order to ensure that tanks are suitable for the carriage of products in accordance with the Cargo Resistance Guide.

Successful in-service performance of a tank coating system depends upon both the correct choice of coating and the adoption of the correct procedures for surface preparation and paint application.

This document provides guidance to the specialised field of cargo tank coating application. It is the result of experience gained by International Paint during the application of sophisticated cargo tank coatings to vessels since 1960, and the requirements for compliance with IMO PSPC MSC.288(87) for Cargo Oil Tanks of Crude Oil Tankers.

The responsibilities for achieving the specific standards outlined and for carrying out surface preparation and paint application rest with the Contracting Company and Shipyard. The responsibility for ensuring that cargoes are suitable for carriage in the tanks rests with the owner. International Paint may be consulted. Under no circumstances do these responsibilities rest with International Paint. We will generally provide for the presence of a Technical Service Representative at key stages during the performance of the contract. The role of the International Paint Technical Service Representative is advisory only unless otherwise specified in the terms and conditions of the contract.

2. PRODUCT SPECIFICATION AND PRODUCT CURE GRAPHS

2.1 SURFACE PREPARATION

Grit blast entire tank to ISO Standard 8501-1 (2007) - Sa2½. A surface profile of between 50 and 100 microns (2 and 4 mils) is required.

2.2 SPECIFICATION

<u>Coat</u>	<u>Product</u>	<u>Colour</u>	<u>Dft</u> <u>(microns)</u>	<u>Dft</u> <u>(mils)</u>
Full	Interline 704HS	Pink	160	6.3
Stripe	Interline 704HS	Grey		
Stripe*	Interline 704HS	Pink		
Full	Interline 704HS	Grey	160	6.3

*In the instance where cargo tanks are externally stiffened, one stripe coat may be omitted. A second stripe coat in difficult to reach areas may be required if target DFT has not been achieved.

OR

(ii)* Full	Interline 704HS	Grey	120	4.7
Stripe	Interline 704HS	Pink		
Full	Interline 704HS	Pink	100	3.9
Stripe*	Interline 704HS	Grey		
Full	Interline 704HS	Grey	100	3.9

Note: Colours may be interchanged. Stripe coats may be applied before or after full coats.

*Consult International Paint to confirm that IMO PSPC COT Type Approval Certificates cover the use of a 3 coat scheme.

2.3 FILM THICKNESS

Maximum Film Thickness

Dry film thicknesses should be kept below 600 microns where practical. Where excessive overlapping is unavoidable, occasional thicknesses up to 750 microns may be acceptable. International Paint must be consulted when other than a small number of film thickness readings fall outside of this range.

Minimum Film Thickness

The specified scheme dry film thickness of 320 microns must be achieved on at least 90% of the total coated surface area. A minimum dry film thickness, equivalent to 90% of that specified, must be achieved on the remaining 10%. Interline 704HS will not coalesce satisfactorily, without thinning, at dry film thickness below 75 microns when airless sprayed.

For further information, consult International Paint.

Application Guidelines

Interline® 704HS

Revision 2 Date 23rd February 2021



2.4 NOTES

- 2.4.1 Refer to the accompanying graphs for recommended overcoating intervals, pot life and curing requirements.
- 2.4.2 Touch up of damages caused during destaging is to be done by brush with Interline 704HS to a minimum dry film thickness of 320 microns (12.6 mils).
- 2.4.3 At temperatures below 25°C, Interline 704HS should be allowed a 30 minute induction time after mixing and prior to application.
- 2.4.4 All thicknesses are to be checked by the International Paint Technical Service Representative on site. Any substandard areas are to be rectified.
- 2.4.5 For application the steel temperature must not be lower than 5°C (41°F) and should not exceed 40°C (104°F). Should steel temperature fall below 5°C (41°F) at any stage, consult International Paint for advice.
- 2.4.6 Relative humidity should not exceed 85%.
- 2.4.7 Areas of overspray are to be sanded down prior to overcoating.
- 2.4.8 Application of a 3-coat scheme will generally result in a reduced requirement for touch-up to achieve the specified film thickness. This can minimise the potential areas of overspray and surface roughness and improve the ease of tank cleaning when in service.

2.5 PRODUCT CURE GRAPHS

- 2.5.1 Pot Life
- 2.5.2 Touch Dry Times
- 2.5.3 Hard Dry Times
- 2.5.4 Curing Times
- 2.5.5 Minimum Overcoating Intervals
- 2.5.6 Maximum Overcoating Intervals

Interline 704HS: Pot Life

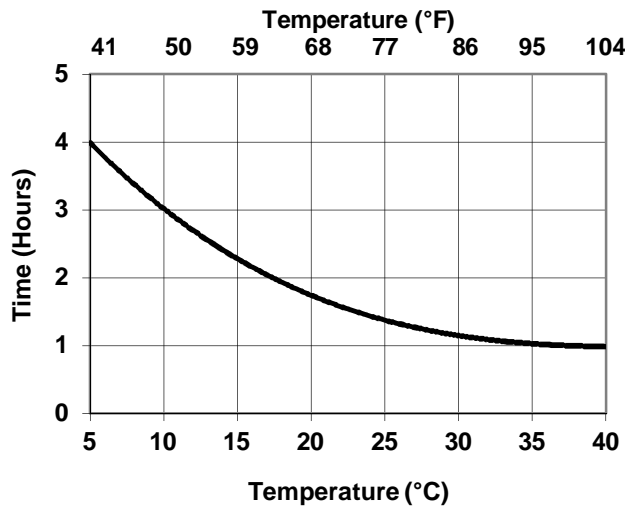

Interline 704HS: Touch Dry

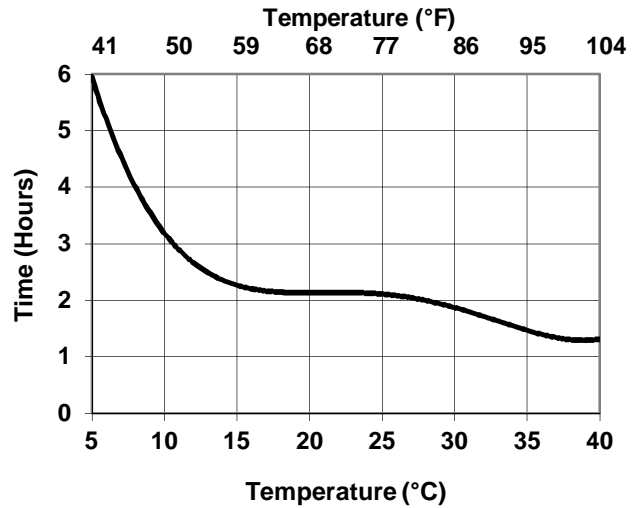

Interline 704HS: Hard Dry

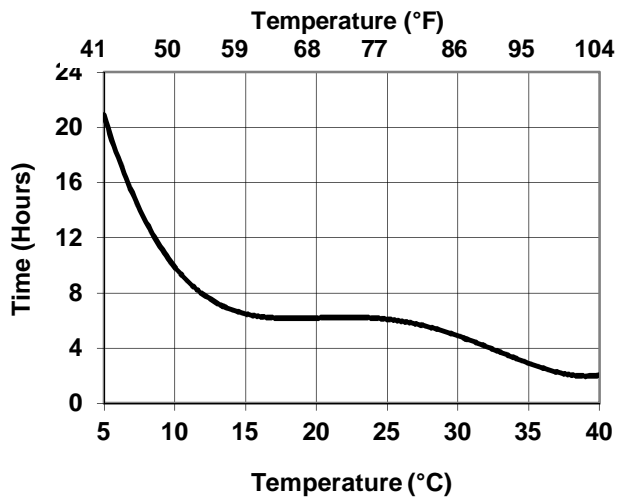

Interline 704HS: Walk-on Time

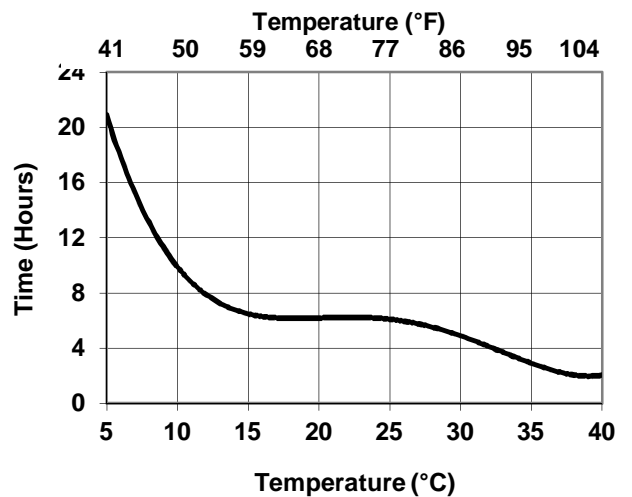

Application Guidelines Interline® 704HS

Revision 2 Date 23rd February 2021



Interline 704HS: Minimum Cure

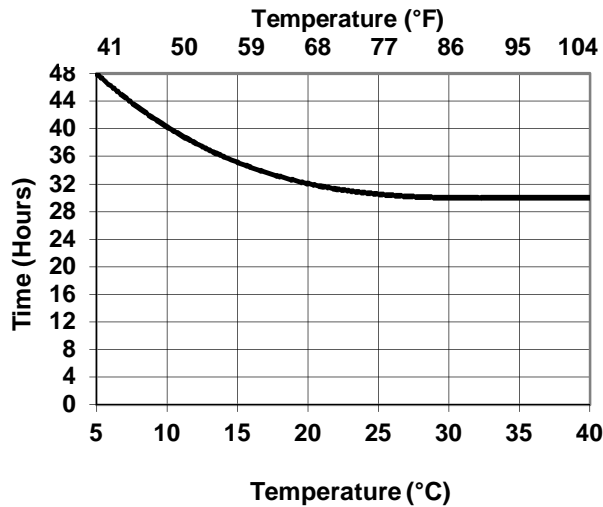

Minimum cure time is defined as the time at which sufficient network formation has occurred for the product to resist ambient environmental conditions.

NOTE it is recommended that temperature and humidity are maintained within recommendations until the time to service entry is achieved (see page 7). If this is not possible, International Paint should be consulted for guidance.

Interline 704HS: Time to water immersion

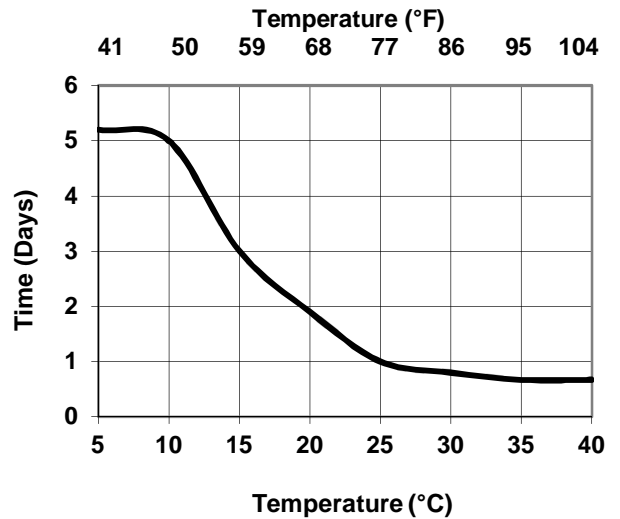

Water immersion refers to water testing to highlight any “holidays” in the coating or ballasting of tanks during sea trials and usually will not exceed 7 days. On deballasting, the tanks must be dried out.

During the cure duration highlighted above, temperatures must be >5°C. If temperature drops below 5°C, or varies considerably during the cure duration, consult International Paint for guidance

Interline 704HS: Time to Service

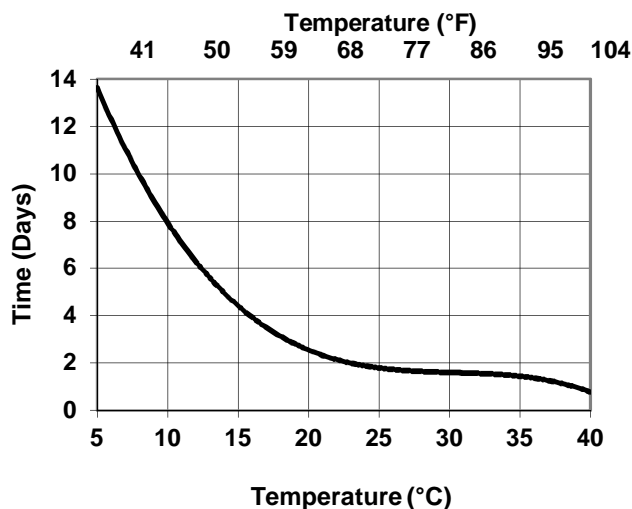

Time to Service refers to cargo immersion.

During the cure duration highlighted above, temperatures must be >5°C. If temperature drops below 5°C, or varies considerably during the cure duration, consult International Paint for guidance

Application Guidelines Interline® 704HS

Revision 2 Date 23rd February 2021



Interline 704HS: Maximum Overcoating

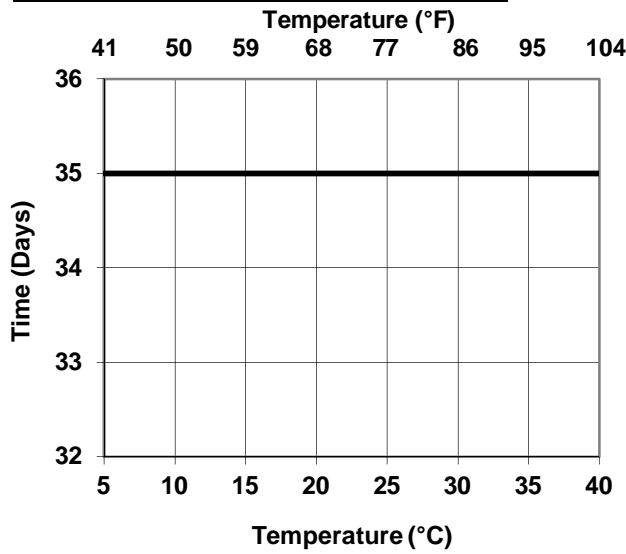

Interline 704HS: Minimum Overcoating

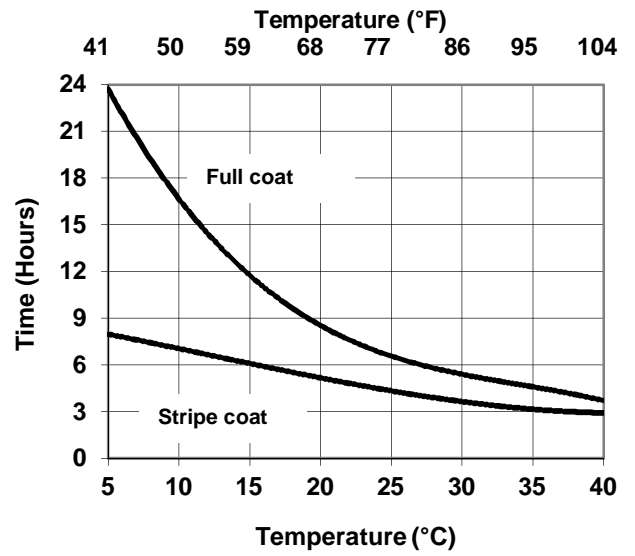

Note: The maximum overcoating interval can potentially be extended by the use of sand papering or power tool. Any mechanical damage through to steel must be fully repaired following guidelines in this document. Please contact International Paint for more details.

3. COATING APPLICATION PROCEDURES

BLASTING COMPLETE TANK PRIOR TO ANY PAINTING

- 3.1 Erect the scaffolding. Refer to Section 5.3 for recommendations.
- 3.2 For cargo tanks, grit blast the entire tank to ISO Standard ISO 8501-1 (2007) - Sa2½. The specified surface profile is required - see Section 2.1.
- 3.3 Upon completion of the blasting, and after inspection by the Contractor Quality Control Department, the International Paint Technical Service Representative will also inspect the whole area and mark up any substandard areas.
- 3.4 All marked areas shall be re-blasted and brought up to the required standard. Any minor areas (Consult International Paint) remaining after blast cleaning has been carried out, where the specified standard has not been met, may be prepared by power tooling to Pt3 (JSRA SPSS: 1984). The whole area is to be vacuum cleaned to remove dust and contamination.
- 3.5 Before coating of the blasted surfaces commences, the amount of residual salt should be measured using the Bresle patch method (ISO 8502-6: 2006 "Extraction of soluble contaminants for analysis – The Bresle method" / ISO 8502-9: 1998 "Field method for the conductimetric determination of water-soluble salts") or similar. These methods are also described in Module No.8 of the International Paint Technical Service training programme. If the result is less than micrograms/cm² progress to 3.1.7. If the result is greater than 5 microgrammes/cm² progress to 3.1.6. The number of tests to be carried out is dependent upon the tank size and a figure should be agreed before the contract begins. Consult International Paint.
- 3.6 The entire tank is to be fresh water washed. After the tank is dry, the salt contamination level is to be re-measured. The process outlined in 3.5 is to be repeated if the level is more than 5 micrograms/cm². The entire tank must then be re-blasted to ISO 8501-1 (2007) Sa2½. The specified surface profile as given in Section 2.1 must be achieved. Salt levels should then be re-measured by following 3.5 above.

1st Full coat

- 3.7 All the areas are to receive a full coat of the first coat of the system to the specified dry film thickness in Section 2.2, within the minimum and maximum thicknesses as given in Section 2.3.
- 3.8 When hard dry, and accepted by the Contractor Quality Control Department, the International Paint Technical Service Representative will check the dry film thickness.
- 3.9 The bottom area, up to 2 metres (6 feet) above the bottom, is to be covered in polythene to prevent dry spray from the upper areas falling on to the bottom.

1ST Stripe coat (and 2ND Stripe coat for a 2-coat system) – Upper areas

- 3.10 All the areas itemised in Section 5.14 in way of the upper area are to receive a stripe coat of the second coat of the system.
- 3.11 The stripe coat is to be inspected by the International Paint Technical Service Representative.
- 3.12 For a 2-coat system repeat steps 3.10 & 3.11 using a stripe coat of the first coat of the system in complex areas as required.

2nd Full coat – Upper areas

- 3.13 The upper areas are to receive a full coat of the 2nd coat of the system to the specified dry film thickness in Section 2.2
- 3.14 When hard dry, and accepted by the Contractor Quality Control Department, the International Paint Technical Service Representative will check the dry film thickness.
- 3.15 For a 2-coat system, the total dry film thickness should be as specified in Section 2.2, within the minimum and maximum thicknesses. Any areas of under thickness are to be brought up to the minimum thickness specified.

2ND Stripe coat (3-coat systems only) – Upper areas

- 3.16 (For a 2-coat system proceed to Section 3.21). For a 3-coat system all the areas itemised in Section 5.14 in way of the upper area are to receive a stripe coat of the 3rd coat of the system.
- 3.17 The stripe coat is to be inspected by the International Paint Technical Service Representative.

3RD Full coat (3-coat systems only) – Upper areas

- 3.18 The upper areas are to receive a full coat of the 3rd coat of the system to the specified dry film thickness in Section 2.2.
- 3.19 When hard dry, and accepted by the Contractor Quality Control Department, the International Paint Technical Service Representative will check the dry film thickness.
- 3.20 The total dry film thickness should be as specified in Section 2.2, within the minimum and maximum thicknesses for a 3-coat system. Any areas of under thickness are to be brought up to the minimum thickness specified.

Destaging

- 3.21 When the full upper area is coated to the required standard the polythene and scaffolding are to be removed from the tank
- 3.22 All damages caused by de-staging, plus areas covered by the scaffolding poles, are to be either vacublasted or disced to the required standard. The whole bottom area is to be cleaned and solvent washed where necessary. All damages are to be touched up with the correct coating system.

1ST Stripe coat (and 2ND Stripe coat for a 2-coat system) – Bottom areas

- 3.23 Areas itemised in Section 5.14, in way of the bottom area, are to receive a stripe coat of the 2nd coat of the system.
- 3.24 The stripe coat is to be inspected by the International Paint Technical Service Representative.
- 3.25 For a 2-coat system repeat steps 3.23 & 3.24 using a stripe coat of the 1st coat of the system.

2nd Full coat – Bottom areas

- 3.26 All areas of the bottom up to a 2 metre (6 feet) level are to receive the 2nd coat of the system to the specified dry film thickness in Section 2.2.
- 3.27 When hard dry, and accepted by the Contractor Quality Control Department, the International Paint Technical Service Representative will check the dry film thickness.
- 3.28 For a 2-coat system, the total dry film thickness should be as specified in Section 2.2, within the minimum and maximum thicknesses. Any areas of under thickness are to be brought up to the minimum thickness specified.

2ND Stripe coat (3-coat systems only) – Bottom areas

- 3.29 (For a 2-coat system proceed to Section 3.32). For a 3-coat system all the areas itemised in Section 5.14 in way of the bottom area are to receive a stripe coat of the first 3rd coat of the system.
- 3.30 The stripe coat is to be inspected by the International Paint Technical Service Representative.

3RD Full coat (3-coat systems only) – Bottom areas

- 3.31 All areas of the bottom up to a 2 metre (6 feet) level are to receive the 3rd coat of the system to the specified dry film thickness in Section 2.2.
- 3.32 When hard dry, and accepted by the Contractor Quality Control Department, the International Paint Technical Service Representative will check the dry film thickness.
- 3.33 The total dry film thickness should be as specified in Section 2.2, within the minimum and maximum thicknesses for a 3-coat system. Any areas of under thickness are to be brought up to the minimum thickness specified.

Water Testing

- 3.34 Finished tanks must be subjected to a seawater or freshwater test to highlight pinholes/irregularities in the tank coating which have not been identified by normal visual inspection. This may be carried out either by:
- full ballasting of the tank for a minimum of 24 hours.
 - full ballasting of the tank. After de-ballasting, the tank should remain closed for at least 48 hours.
 - seawater re-circulation using the tank washing system. A minimum of 2 cycles are to be run, and the tank should then remain closed for at least 48 hours.

Where method b) or c) is utilised, water to a depth of 1m should remain in the tank while in a closed condition, to ensure humid conditions are maintained.

If freshwater is used the test duration must be doubled.

The maximum duration of seawater testing/immersion (e.g. if ballasting the tanks during sea trials at newbuilding) should not exceed 7 days. If extended water immersion times are required, contact your local representative for guidance

Application Guidelines

Interline® 704HS

Revision 2 Date 23rd February 2021



The minimum curing period prior to water testing is shown below. If temperature drops below 5°C, or varies considerably during the cure duration, consult International Paint for guidance

Temperature °C	Temperature °F	Curing Days
5	41	5
10	50	5
15	59	3
20	68	1
25	77	1
30	86	16 hrs

- 3.35 Following testing, the tank should be thoroughly washed down with fresh water and dried, and any defective area repaired in accordance with the recommendations of the International Paint Technical Service Representative. These recommendations will be based upon those outlined in Section 6.

4. TECHNICAL INSPECTION AND PROJECT CONTROL

Project control by regular inspection and agreement on future action is vital to successful tank coating projects, and in maximising the potential of a coating system.

All parties involved in the cargo oil tank coating work must agree an inspection procedure prior to work commencing, this should outline how and when both work and inspection will be undertaken.

Prior to commencing the project the contractor(s) must be provided with copies of the relevant product data sheets. Attention should be drawn to pack sizes, mix ratios, thinning restrictions etc.

The International Paint Technical Service Representative must be present during initial mixing of the first drums of product to be applied to ensure that all parties are aware of mixing and application characteristics.

Daily meetings should be arranged to confirm performance of the work and inspection schedules, minutes of these meetings must be taken and circulated to all participants. Representatives of the contractor, shipyard and ship owner would normally be present at these meetings.

In the event of work continuing at any stage without the approval of International Paint, the Company cannot be held responsible for any subsequent failure of the tank coating system on the areas concerned. Those areas **MUST** be specifically excluded from the performance guarantee. Such an event is termed an **EXCEPTION**. All parties **MUST** be officially informed in writing using the standard International Paint Coating Exception Report Form.

International Paint, and any other authorised personnel, may inspect any stage in the process. If additional inspections are considered necessary because of on-site conditions or by agreement prior to commencement of the contract, then the contractor must obtain written approval for that stage from International Paint before continuing.

Contractors must supply interpreters if necessary.

On completion of the contract all relevant documentation must be retained, and suitably archived (for a minimum period of 12 years, or longer if required by the guarantee period or defined by local procedures), by the Local Technical Service Manager.

Inspection equipment for measurement of blast profile depth, relative humidity, wet and dry film thickness, etc. should be of approved types and be correctly calibrated.

Note: When measuring the dry film thickness of coatings, the DFT gauge must be calibrated prior to use and measurements made in accordance with ISO 2808:2007, unless regulations dictate that an alternative standard should be used.

5. GENERAL NOTES

5.1 TANK CONDITION

5.1.1 Newbuilding

Prior to commencement of blasting it is essential that the tanks are clean, dry, and in a condition suitable for surface preparation and application of the tank coatings. The following briefly outlines the minimum requirements:

All rust, grease, dust, salt and oil must be removed from all surfaces.

All hot work in way of tanks must be complete.

Heating coils (if to be fitted) should be installed.

All cargo lines should be fitted and tested.

Cargo suction strums (if fitted) should be removed in order to give total access.

After final tank testing, tanks should be fresh water washed and dried, especially if they have been in contact with sea water.

Defective steelwork, prior to contract commencement, should be repaired in line with the guidance notes given in 5.2 (Steelwork Preparation).

5.1.2 Maintenance & Repair

Prior to the commencement of blasting it is essential that the tanks are clean, dry, and in a condition suitable for surface preparation and application of tank coatings. The following briefly outlines the minimum requirements:

Tanks must be cleaned and gas free.

Any blisters present must be burst and blister caps removed from surface.

Heavy scale must be removed from all surfaces.

Scale, debris and cargo residues must be removed from the tanks.

All grease and oil must be removed from all surfaces.

All hot work in way of tanks must be complete.

Cargo suction strums (if fitted) should be removed in order to give total access.

All tanks must be fresh water washed.

Any areas of steel renewal should be prepared in the manner described in 5.2 Steelwork Preparation.

5.2 STEELWORK PREPARATION

The steel surface to be coated shall be prepared so that coating can achieve an even distribution at the required NDFT and have an adequate adhesion by removing sharp edges, grinding weld beads and removing weld spatter and any other surface contaminant to grade P2

Edges to be treated to a rounded radius of minimum 2mm, or subjected to three pass grading or at least equivalent process before painting - Refer to standard ISO 8501-3: 2001. Preparation of steel substrate before application of paints and related products - Visual assessment of surface cleanliness

ITEM	PROBLEM / SOLUTION
Sharp Edge	<p>Edges should be treated to a rounded radius of minimum 2mm, or subjected to three pass grinding or equivalent.</p>
Weld Spatter	<p>1. Remove spatter observed before blasting by grinder, chipping hammer etc.</p> <p>2. For spatter observed after blasting:</p> <ol style="list-style-type: none"> Remove with chipping hammer /scraper etc. Where spatter is sharp, use disc sander or grinder until obtuse Obtuse spatter – no treatment required
Plate Lamination	<p>Any lamination to be removed by grinder or disc sander</p>
Undercut	<p>Where undercut is to a depth exceeding 1mm and a width smaller than the depth, repair by welding or grinding may be necessary</p>
Manual Weld	<p>For welding bead with surface irregularity or with excessive sharp edges, remove by disc sander or grinder</p>
Gas Cut Surface	<p>For surfaces of excessive irregularity, remove by disc sander or grinder</p>

At newbuilding, pre-blasting of tank welds is recommended to ensure undercut, roughness, blow holes, etc are properly repaired ahead of full tank blasting.

5.3 SCAFFOLDING

Tubular scaffolding must not mask surfaces to be coated. Where contact is necessary then spade ends should be used.

Staging must afford easy and safe access to all surfaces to be coated and should be between 15cm and 30cm (6 and 12 inches) from vertical surfaces which are to be coated.

Where bulkheads are corrugated, staging should be erected such that it extends into the corrugations in order to assist safe inspection. Cross-staging must be firmly secured.

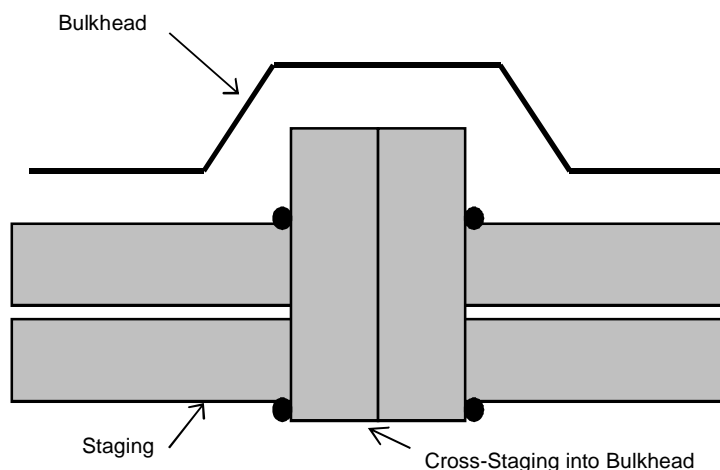

Tubular scaffolding must be plugged or capped prior to grit blasting to prevent the ingress of grit and dirt.

Staging should be designed to allow thorough cleaning. Where scaffolding is wooden, International Paint recommend that it be of the 'turn over' type, when local safety regulations permit.

Distance between staging levels should not exceed 2 metres (6 feet).

If fixed staging lugs are fitted, these should be stainless steel.

Staging layout should be such that ventilation is not rendered ineffective.

Care must be taken when removing scaffolding in order to keep damages to a minimum. Any damages should be repaired in accordance with the recommendations of the International Paint representative on site.

It is recommended that temporary rubber matting/protection is used to protect the bottom areas and inside coaming/access to avoid coating damage during the de-staging.

5.4 CARGO LINES

The internal areas of cargo pipelines should be coated, if required, prior to fitting on the vessel. Care must be taken during fitting to minimise damage.

Areas of externals of cargo pipelines, which will be covered by pipe clips, should be blasted and coated prior to fitting.

Cargo pipeline exterior should be blasted and coated at the same time as the lowermost 2 metres of the tank. Any over blast or over spray affecting surrounding areas must be repaired in accordance with the recommendations of the International Paint representative on site.

5.5 HEATING COILS (IF FITTED)

Heating coils in position during blasting and coating should be masked with suitable material.

Masking, fitted to heating coils before blasting, must be removed and the coils cleaned prior to coating in order to avoid contamination caused by grit falling on to freshly applied paint. Coils should be re-wrapped prior to painting.

The material used for masking when painting should (if possible) be of a type which is absorbent, thus ensuring no contamination from paint flaking from masking on to painted surfaces beneath.

Whenever possible, heating coil brackets should be of stainless steel. The heating coils must be electrically insulated from the brackets to avoid any electrolytic action which would give rise to corrosion.

5.6 VENTILATION

Ventilation is necessary during abrasive blasting operations to ensure adequate visibility. Flexible trunking should be used to allow the point of extraction to be reasonably close to the personnel carrying out the blasting.

During and after coating application the ventilation system and trunking must be so arranged such that “dead spaces” do not exist. As solvent vapours are heavier than air, and will tend to accumulate in the lower areas of tanks, it is important that they are extracted from those areas. This must be balanced with fresh air being introduced into the tank.

Equipment used must not re-introduce abrasive dust, solvent vapour etc. into the tank. For this reason a positive pressure, above normal atmospheric pressure, should be maintained inside the tank. As a “rule of thumb” fresh air supply/extraction should be in the approximate ratio of 4:3.

Ventilation must be maintained during application and continue whilst solvent is released from the paint film during drying. Failure to do this may result in solvent retention within the coating system that will adversely affect its long-term performance. It must be maintained for a minimum period of 48 hours after coating application has been completed unless otherwise agreed with International Paint.

The level of ventilation employed must take account of the Lower Explosive Limit (LEL) of the product being applied and comply with local legislative requirements. (The LEL is the minimum concentration of vapour in air, expressed as a percentage, that will ignite). International Paint recommend that this is such that vapour concentrations do not exceed 10% of the LEL. This figure is in line with general industry standards and the requirements of the United Kingdom Health & Safety Executive (Information Document HSE 703/13 “Application of Surface Coatings to Ship’s Tanks”) and the United States Department of Labour Occupational Safety and Health Administration (OSHA) regulation 1915.36(a)(2).

The ventilation requirement can be calculated from the required air quantity (RAQ) to 10% of the LEL figures and the product application rate. A typical paint application rate by airless spray is 75-100 litres (19.7-26.3 U.S. Gallons) per hour per sprayer. Venting to 10% of the LEL is considered to provide a reasonable margin of safety to allow for possible higher local concentrations due to the complex geometry of tanks. Nevertheless, care should be taken when setting up ventilation/extraction systems, to ensure that 10% figure is not exceeded. If the level of ventilation is reduced during coating application, in order to minimise possible dry spray, the paint application rate must also be reduced to ensure that solvent vapour levels remain below 10% of the LEL.

Immediately following application and until the coating is dry, rapid air-flow across the wet paint film should be avoided, particularly if there is a large difference between the incoming air temperature and the substrate temperature.

Responsibility rests with the shipyard/contractor to ensure that the requisite equipment is available and operated in such a way that these requirements are met. International Paint will provide all of the information needed to allow the shipyard/contractor to calculate ventilation requirements. However, International Paint does not accept responsibility for the equipment, its operation, or the monitoring necessary to ensure that the requisite ventilation requirements are met.

All equipment used after the commencement of paint application must be electrically safe in operation.

Provision must be made by the contractor/shipyard for continuous, round the clock, surveillance of ventilation equipment.

5.7 DEHUMIDIFICATION

Dehumidification equipment, when required, must be of adequate capacity to maintain the condition of blasted steelwork to the required standard. Additionally, in order to prevent condensation, the steel temperature must always be at least 3°C (5°F) above the dew point.

Coatings may only be applied to surfaces which have been maintained in a dry condition with the steel temperature at least 3°C (5°F) above the dew point for more than one hour. The surfaces must be visibly dry and clean at the time of application.

Tank Coating must only be undertaken under acceptable atmospheric conditions, otherwise adverse effects may occur.

As a guide, relative humidity levels of 40-60% give optimum results, although there will be no significant detrimental effect on performance if the coating is applied outside of this range. However, application should not take place if the relative humidity is greater than 85%.

Control of RH to < 85% should be maintained at least until minimum cure is achieved (whereby sufficient network formation has occurred to provide resistance to environmental conditions – see Section 2). However, as best practice International Paint recommend that dehumidification is maintained until time to service is reached (See page 7). Provision should be made for 24 hour surveillance of equipment.

5.8 HEATING

If heating is necessary to satisfy the painting specification, it should be by means of a heat exchange system, i.e. air admitted to the tank should not pass directly through a combustion chamber.

Temperatures should be maintained at $\geq 5^{\circ}\text{C}$ for the duration of the contract from application to cure and provision should be made for 24 hour surveillance of equipment by the contractor/shipyard. Should temperatures drop below 5°C, consult International Paint for guidance.

5.9 LIGHTING

Lighting during blasting and painting must be electrically safe and provide suitable illumination for all work. As a guide, lighting may be considered suitable if this text can be read at a distance of 30 centimetres (12 inches) from the eye.

Ideally, the lighting should be powerful mains supplied spotlight with background lighting on at all times in the interests of safety.

Powerful mains spotlighting must be provided when inspection work is being carried out.

5.10 STORAGE (AT POINT OF APPLICATION)

The paint must be stored out of direct sunlight so that the temperature of the material will not exceed 35°C (95°F) for prolonged periods of time.

When ambient temperatures can be expected to fall below 5°C (41°F), base and curing agent must be stored in premises, (storeroom, hut, etc), which are heated to a temperature in excess of 5°C (41°F) for a period of not less than 48 hours immediately prior to use (unless stated otherwise on the product technical data sheet).

5.11 GRIT BLASTING

5.11.1 General

The main universal standard of surface preparation normally specified for cargo tank coatings is ISO Standard ISO 8501-1 (2007) – Sa2½

In general, the following comments apply to this standard.

Sa2½ - in practice, this is considered to be the best standard a skilled blasting operative can consistently achieve.

Comparative Standards

<u>ISO 8501-1: 2007</u>	<u>Japanese Standard on new steel</u>	<u>SSPC Standard</u>
Sa2½	JA SH2	SSPC-SP10

In cases where the substrate is corroded or pitted, it may be necessary to fresh water wash the areas after abrasive blasting, then re-blast, in order to ensure complete removal of soluble corrosion products.

5.11.2 Compressed Air

Air used for blasting must be clean, oil free and dry. The pressure should be at least 7kg/cm² (100lb/sq inch) at the nozzle.

5.11.3 Abrasive

Abrasives used for blasting must be dry and free from dirt, oil, grease and suitable for producing the standard of cleanliness and profile specified. The abrasive must therefore be in accordance with the specifications given in ISO 11126 - Parts 1 to 8 and each delivery should carry a certificate of conformity to this specification.

If blasting abrasive is supplied on site without a certificate of conformity, the material should be tested by the yard or contractor in accordance with the methods given in ISO 11127 - Parts 1 to 7.

Particular attention should be given to ISO 11127 - Part 6, where the level of water soluble contaminants must not give a conductivity value greater than 25mS/m, and ISO 11127 - Part 7, where the level of water soluble chlorides must not exceed 0.0025% by weight.

Iron or steel abrasives can be used for in-situ open blasting. Specifications for metallic abrasives are given in ISO 11124 - Parts 1 to 4 and the corresponding test methods in ISO 11125 - Parts 1 to 7. If used, careful and thorough cleaning must be carried out at all stages of the operation to ensure that no abrasive remains in the tank as this may subsequently corrode.

Although not recommended, recycled grit may be used providing it is dry, has been shown to be free from contamination by dirt, oil, grease, and has been tested in accordance with the above ISO standards.

5.11.4 Blast Profile

The amplitude of the blast profile depends upon the type of coating to be applied. Measurement on site should be by profile gauge or other mutually acceptable instruments.

Measurement of surface profile using comparators is described in ISO 8503-2 using comparators detailed in ISO 8503-1. A blast profile of 50-100 microns is required and can be measured using:

- a) ISO 8503-3: Focusing microscope
- b) ISO 8503-4: Stylus

5.12 CLEANING

Prior to initial blasting inspection, the bulk of spent grit must be removed.

Any substandard areas should be identified and must be brought up to the specified standard.

All marking paint, chalk, etc, used to identify substandard areas must be removed after substandard areas are rectified. The marks made, if left, will cause blistering and detachment of subsequent coats.

Following provisional approval of the blast standard, all remaining traces of grit and dust must be removed from all areas including scaffolding, using industrial vacuum cleaners fitted with brushes, or by other suitable methods agreed by International Paint. The quantity of dust remaining should be no greater than Pictorial reference 1: ISO 8502-3 and be of no greater size than Class 2: ISO 8502-3.

Final approval of a substrate for coating application must be confirmed after final cleaning.

Mats for wiping feet, (or overshoes), should be placed at the entrance of tanks, and the area immediately surrounding them kept in a clean condition.

5.13 PAINT APPLICATION

All paints should be applied by airless spray except for stripe coats where brush or roller should in general be used.

Efficient mechanical stirrers for the correct mixing of paint must be used.

At temperatures below 25°C, Interline 704HS should be allowed a 30 minute induction time after mixing and prior to application.

Available air pressure and capacity for spray equipment should be at least 5.5kg/cm² and 1.4m³/min (80 psi and 50 cfm).

All spray equipment must be in good working order and be capable of performing to the output requirements defined in International Paint product technical data sheets.

It is recommended that airless spray pump ratios of 40:1 or greater should be used.

Tips should be the size stipulated on the product technical data sheet, or as agreed with the International Paint representative on site. Tips must not be in a worn condition.

Both during and following application of paint, all operatives entering the confines of coated tanks must wear soft soled shoes.

Marker pens are commonly used to mark-up areas of tanks, which require attention during the coating process. The marks made on the underlying coat can cause blistering and detachment of subsequent coats – see photographs of test panels below marked using unapproved marker pens between coats. All marker pens used must be technically approved by the International Paint Worldwide Marine Laboratories prior to use. Information on approved marker pens is available from IP Technical Service Representatives.



Detachment of topcoat following use of unapproved pen



Blistering of topcoat following use of unapproved pen

5.14 STRIPE COATS

Stripe coating is an essential part of good painting practice. Typical areas where stripe coats must be applied include:

- behind bars
- plate edges
- cut outs i.e. scallops, manholes etc
- welds
- areas of difficult access
- ladders and handrails
- small fitments of difficult configuration
- areas of pitting









Note: The above list is not comprehensive, all areas must be included.

In general, stripe coats should be applied by brush or roller, depending upon items concerned.

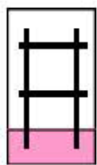
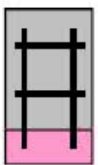
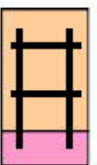
In exceptional circumstances it may be acceptable to apply a stripe coat to the backs of angle bars by narrow angle spray. The use of spray applied stripe coats however, must be discussed and agreed with the International Paint representative on site.

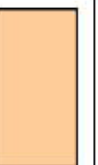
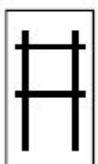
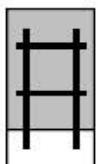
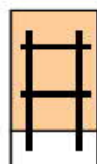
5.15 COATING PROCEDURES

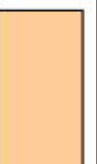
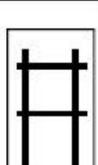
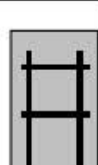
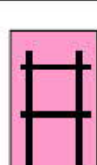
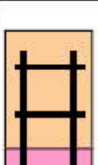
The following diagrams show four typical “model” coating procedures for cargo oil tanks.

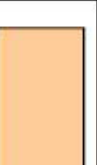
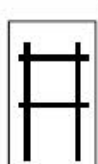
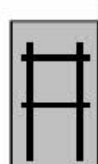
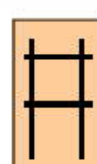
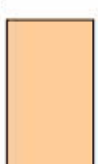
<p>A)</p>	 Blast Bottom Area	 1 st Coat Bottom Area	 Scaffold	 Blast Upper Area	 Fully Coat Upper Area	 De-stage & Repair	 Fully Coat Bottom Area	<p><u>ADVANTAGES</u> No overblast/ricochet damage on high build coats. Mechanical damage restricted. No problem cleaning uppers after blasting bottoms.</p> <p><u>DISADVANTAGES</u> Long overcoating time for primer or first coat required. Overlap requires preparation. Careful cleaning of bottom required.</p>
<p>B)</p>	 Scaffold	 Blast Upper Area	 Fully Coat Upper Area	 De-stage & Repair	 Blast Bottom Area	 Fully Coat Bottom Area	<p><u>ADVANTAGES</u> No holding primer required. No potential overcoating problems.</p> <p><u>DISADVANTAGES</u> Overblast / ricochet damage on coated areas. Overlap requires preparation. Cleaning of uppers after blasting bottom difficult without staging.</p>	
<p>C)</p>	 Scaffold	 Blast Total Area	 1 st Coat Total Area	 Fully Coat Upper Area	 De-stage & Repair	 Fully Coat Bottom Area	<p><u>ADVANTAGES</u> Continuous blasting of tank restricts overblast. No cleaning problem.</p> <p><u>DISADVANTAGES</u> Blasting bottom with scaffolding in place. Long overcoating time for primer or first coat required. Scaffold contact points on bottom need preparing. Overlap requires preparation. Higher level of dehumidification required.</p>	
<p>D)</p>	 Scaffold	 Blast Total Area	 Fully Coat Total Area	 De-stage & Repair			<p><u>ADVANTAGES</u> Continuous blasting of tank restricts overblast. No cleaning problem. No overlap problem.</p> <p><u>DISADVANTAGES</u> Possible dry spray on bottom when coating uppers. Scaffold contact points on bottom need preparing. Bottoms likely to be damaged whilst de-staging.</p>	

6. REPAIR PROCEDURES

6.1 INTRODUCTION

These repair procedures are recommended for damages either at the initial coating stage or where breakdown of coating has occurred during the service life of the vessel.

The repair procedure recommended will depend upon the extent of damage involved but can be split into:

- i) Repairs of major areas
- ii) Repairs of minor areas

6.2 MAJOR REPAIRS

A Major repair should essentially be dealt with as if the project were beginning. The recommendations given earlier for steel preparation, coating application, etc. MUST all be adhered to.

6.3 MINOR REPAIRS

Under this heading are repairs to areas damaged either at the initial coating stage, i.e. caused by de-staging, etc or caused during service, i.e. tank cleaning equipment damages, spot corrosion, etc. The principle requirements are:

The area to be repaired must be fresh water washed and dry.

Remove any corrosion by means of either:

- vacuum blasting
- hand tools, i.e. disc sander and grinder.

Any pittings which, in the opinion of the Classification Society, do not need re-welding, should be prepared by needle gun and/or cone shaped grinder to remove corrosion deposits.

It is not normally recommended to use filler in pittings as it is likely to detach, taking with it any paint which has subsequently been applied, thus exposing the steelwork to possible further corrosion.

If, however, it is decided to use filler, it must be applied after the first coat of the system, then overcoated with the remaining coats.

Abrade area immediately surrounding repair to provide key for subsequent paint application.

Apply the paint system in accordance with our recommendations. If small areas are involved and application is by brush, several coats may be required to achieve the correct dry film thickness.

Cure time - when minor repairs have been carried out the cure time can be reduced to 75% of that recommended for full tank applications.

7. HEALTH & SAFETY

7.1 INTRODUCTION

Some tank coatings contain volatile flammable organic solvents which can form explosive mixtures with air. Definite safety precautions must be taken whilst applying this type of coating in the confines of a ship's cargo tank. Detailed attention must be given to the following points:

- Danger of explosion or fire.
- Provision of a suitable breathing environment for workers.
- Prevention of skin irritation problems.
- Use of paints which have been specially formulated for use in tanks.

7.2 DANGER OF EXPLOSION OR FIRE

The key factors in preventing an explosion or fire are:

- Adequate ventilation.
- Elimination of naked flames, sparks and any ignition sources.

Any organic solvent based coating could, merely by the normal process of drying, give off sufficient solvent vapour to produce an explosive mixture in a tank when the vapour concentration reaches or exceeds 1% by volume in air. However, at 1% the solvents in the coatings produce an unpleasant odour, (often with irritating skin effects) and smarting of the eyes. These symptoms must be taken as a warning sign that better ventilation is needed. 0.1% solvent vapour in air is normally recommended to give a tenfold safety margin and at this concentration, no explosion can occur and no operator effects should be noticed.

Sampling apparatus to detect the exact concentration of solvents should be used at regular intervals, particularly in "dead spots" where locally high concentrations may occur.

7.3 VENTILATION

(Note: This must be read in conjunction with General Note 5.6).

Ventilation is necessary during abrasive blasting operations to ensure adequate visibility. Flexible trunking should be used to allow the point of extraction to be reasonably close to the personnel carrying out the blasting.

During and after coating application it is essential that solvent vapours are removed to ensure that the level present in the atmosphere does not rise above that recommended in the section (7.2) dealing with "Danger of Explosion and Fire". This means that the ventilation system must be arranged such that "dead spaces" do not exist and the ventilation must be continued both during the time that application is proceeding and also whilst solvent is released from the paint film during the drying process. Particular care must be taken to ensure that solvent vapour, which is heavier than air, does not accumulate in the lower areas of the tanks.

The amount of air per minute for ventilating to 10% of the LEL (lower explosive limit) can be regarded as the required air quantity multiplied by rate of application per minute. The required air quantity is the amount of air needed for each litre of paint to ventilate to the required level.

RAQ = Required Air Quantity
LEL = Low Explosive Limit

Ventilation required (m³/minute) = RAQ x the application rate (litres/minute). The likely approximate application rate can be calculated from figures available from the application equipment supplier and will depend on the airless spray pump pressure and the orifice size of the tip used.

The geometry and size of tanks makes each one a separate problem, and it is essential that the ventilation arrangement, fan type, etc is checked as being suitable before painting commences.

In the event of a failure of the extraction/ventilation system paint application must be stopped and the tanks evacuated of personnel immediately.

7.4 **ELIMINATION OF IGNITION SOURCES**

Safety is the overriding consideration with this type of tank coating work, and the Contractor and Crew must be made fully aware of all aspects of the operation.

Welding, cutting or grinding in the tank must be forbidden until paint fumes are totally ventilated. This also applies to all areas within a 20m (60 feet) radius of tank and trunking outlets.

Coamings and hatch openings must be covered so as to efficiently prevent spark entry where welding is being carried out on the superstructure.

Lights, including hand torches, must be certified by the manufacturer as flash proof and suitable for use in solvent laden atmospheres.

Smoking must be prohibited in or near tanks or extraction systems.

No electrical junction boxes should be allowed in tanks.

Airless spray equipment must be earthed (because of the danger of static electricity build-up)

Mobile telephones, electrical cameras, and any equipment that is not intrinsically safe, must not be used in or near tanks or extraction systems until paint fumes are totally dispersed.

7.5 **SOLVENT VAPOUR AND PAINT MISTS - PROTECTION OF PAINTING PERSONNEL**

No ventilation system can reduce solvent vapour levels to below the Occupational Exposure Limit for solvents whilst tank coating is in operation. Painters must, therefore, wear air fed hoods or pressure fed masks with additional eye protection. (Please note: air fed hoods which provide a curtain of air across the visor are available. These help to prevent settlement of spray mist on the visor). Normal protective clothing must be worn, e.g. overalls, gloves, and suitable footwear of non-spark type.

7.6 SKIN IRRITATION

If proper protective clothing has been worn, e.g. overalls, gloves, air fed hood, etc no discomfort should be experienced from skin irritation. Any small areas not protected by clothing, e.g. wrists or neck, can be treated with a non-greasy barrier cream. (Petroleum jelly is not recommended as this can assist the transport of solvents into the skin).

Any areas of skin accidentally contaminated with paint must be thoroughly washed with soap and water. A skin conditioner that is designed to replace the natural oils in the skin can be used.

Note

1. The preceding safety information is given for guidance only.
2. It is imperative that, prior to the commencement of any tank coating project, local Regulations regarding Health and Safety be consulted.

All representations and statements concerning the product(s) in this publication are accurate to the best of our knowledge. Statements made in this publication are advisory only and are not intended to be specific recommendations or warranties of any product, combination of products or fitness for any particular purpose. To the extent permitted by law, we do not accept any liability to any person for any loss or damage (direct or indirect) that may arise from any use or reliance on any of the methods or information contained in this publication for any purpose.

Unless otherwise agreed in writing, all products supplied and technical advice or recommendations given are subject to the Conditions of Sale of our supplying company. Any warranties, if given, are contained in those standard Conditions of Sale and are the only ones made with respect to any products we sell to you or advice or recommendations we give to you.

We hereby disclaim any warranties or representations, expressed or implied, by operation of law or otherwise, including, without limitation, any implied warranty of merchantability or fitness for a particular purpose.

For each of our products the relevant Product Data Sheet, Material Safety Data Sheet and package labelling comprise an integral information system about the product in question. Copies of our Product Data Sheets and Material Safety Data Sheets are available on request or from our website: www.international-marine.com.

 **International** and all product names mentioned in this publication are trademarks of, or licensed to, Akzo Nobel.